

QBY-BT series Pockels cell drivers

User manual

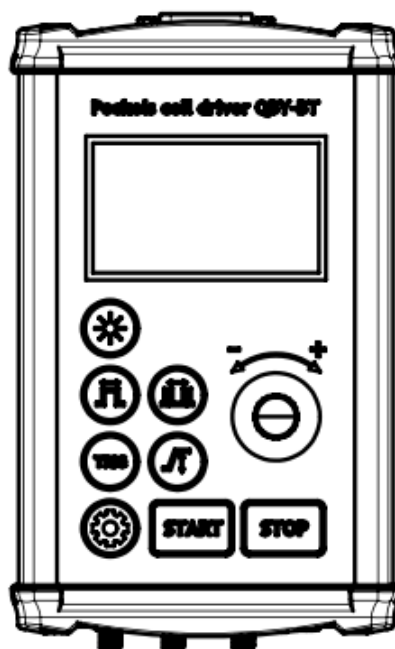

Warning! This equipment may be dangerous.
Please read the entire user manual carefully before using the product.

Important note: please measure the output with symmetrical (differential) high voltage probe only. Measurement made with inappropriate equipment is a common cause of driver's failure.



Table of content

TABLE OF CONTENT	2
OVERVIEW / APPEARANCE	3
CONTENTS OF DELIVERY	3
DESCRIPTION – TOP VIEW	4
DESCRIPTION – SIDE VIEW (HV OUTPUT SIDE)	9
DESCRIPTION – SIDE VIEW (INPUTS AND INTERFACES)	10
SAFETY.....	12
OPERATIONS.....	12
TECHNICAL NOTES.....	13
SPECIFICATIONS	14
DIMENSIONS.....	16
HOW TO ORDER?.....	16
RS485 INTERFACE DESCRIPTION	17
PERFORMANCE	18
TYPICAL OUTPUT	19

Overview / Appearance

QBY-BT is a laboratory Pockels cell driver with following unique features:

- Wide range of output voltages – 0-4kV in one device
- Fast rise and fall times – 3-4ns
- Extra low delay/jitter in external synchronization mode
- Fully functional internal synchronization mode – pulse width is smoothly adjustable in 10-1000ns range with sub-nanosecond step, pulse repetition rate is also smoothly adjustable



The driver is perfectly suitable for control of regenerative amplifiers.

Contents of delivery









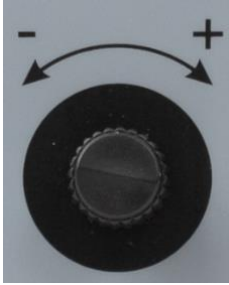

By default we supply a stand-alone version of the driver including:









- QBY-BT Pockels cell driver – 1pc
- AC/DC power supply – 1pc
- HV Output cable (15cm long) – 1pc

Additional cables, e.g. Interface or BNC-SMA as well as demo software utility for Windows OS is available on request.



Description – top view



CONTROL	DESCRIPTION
	<p>Knob</p> <ol style="list-style-type: none"> 1. Edit parameters: <ul style="list-style-type: none"> - Clockwise rotation – increase the parameter - Counterclockwise rotation – decrease the parameter - Press (push) – apply changes 2. Menu navigation: <ul style="list-style-type: none"> - Rotation – menu navigation - Press (push) – sub-menu selection, check-box state change, parameter edit 3. Screen saver – exit screen saver screen 4. Error/warning messages – skip message
	<p>Display</p> <p>Main screen:</p>  <p>Status pictograms:</p> <ul style="list-style-type: none">  - internal synchronization  - external synchronization  - synchro output is enabled  - HV output is enabled (internal synchronization mode)  - HV output is enabled (external synchronization mode)  - fan is rotating  - Modbus connection is active

CONTROL	DESCRIPTION
	<p>Pulse amplitude button</p> <p>Pulse amplitude screen:</p> 
	<p>Pulse width button</p> <p>Pulse width screen:</p> 
	<p>Pulse repetition rate button</p> <p>Pulse repetition rate screen:</p> 
	<p>External/internal triggering</p>
	<p>Display on/off</p>

CONTROL	DESCRIPTION
	<p>Settings screen – multilevel menu</p> <p>Menu top level:</p>  <p><i>Pictograms from left to right:</i></p> <ul style="list-style-type: none"> - Synchro output options - Modbus options - Miscellaneous options - About the device - Exit menu <p>Synchro output options:</p>  <p>Modbus options:</p>  <p>Miscellaneous options:</p>  <p>About the device:</p> 

CONTROL	DESCRIPTION
	<p>Start button Start the driver – HV pulses are applied to the output</p>
	<p>Stop button Stops the driver – HV pulses are removed from the output</p>

Description – Side view (HV Output side)

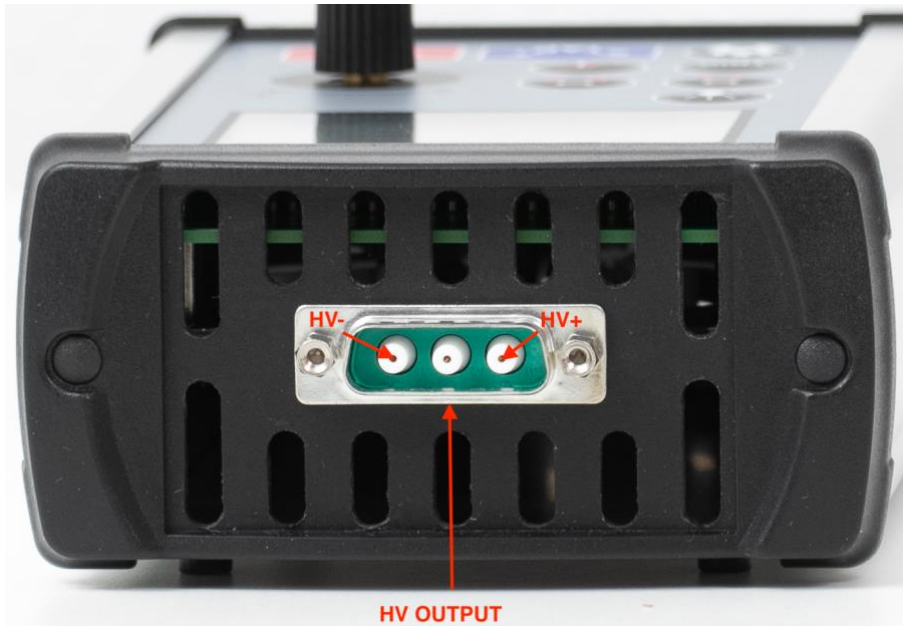

**HV OUTPUT (Harting 09 69 210 0033 housing,
09 69 281 2550 contacts):**

PIN	DESIGNATION	DESCRIPTION
A1	HV-	High voltage output (negative swing)
A2	N/C	Not connected
A3	HV+	High voltage output (positive swing)

Description – Side view (inputs and interfaces)

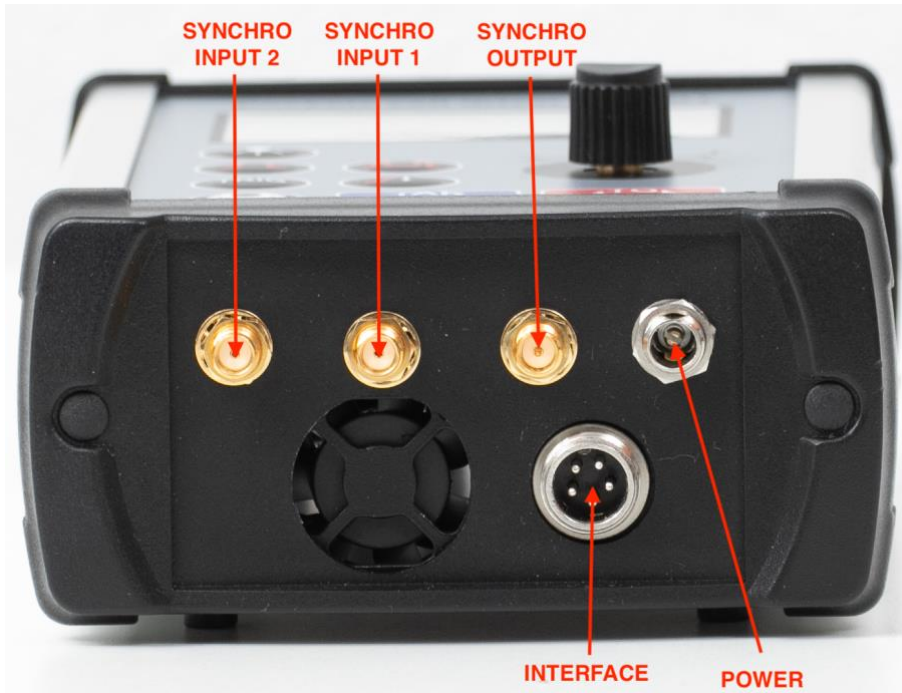

POWER (Switchcraft L712RALP):



+24VDC, 1A power connector.

INTERFACE (Connfly electronic DS1110-01-5):

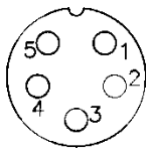

PIN	DESIGNATION	DESCRIPTION
1	Boot select	Do not connect (reserved by manufacturer)
2	RS485 B	RS485 interface
3	RS485 A	
4	+5VDC	+5VDC, 150mA auxiliary output
5	GND	Interface ground

SYNCRO INPUTS – 2PCS (Molex 732512201):

In external synchronization mode a trigger signal applied to Synchro Input #1 starts HV pulse at driver's output, another trigger signal applied to Synchro Input #2 ends HV pulse at driver's output.

Signal characteristics are 5V TTL, 50Ω both for Synchro Input #1 and #2.

SYNCRO OUTPUT (Molex 732512771):

When enabled in driver's Settings menu, a synchro output pulse is applied to this connector. It can be used for synchronization of other equipment with the driver, e.g. when the driver is run in Internal synchronization mode.

Signal characteristics are 5V TTL, 50Ω.

Safety

Warning! This equipment produces high voltages that can be very dangerous.
Be careful in a high-voltage appliances area

- Do not open the coverage case of the Pockels cell driver
- Do not self-repair the driver
- Assemble the entire setup before powering up the device
- Avoid casual contacts of personnel with output cables and with a load
- Do not connect / disconnect cables while driver is turned on
- Do not turn the driver on if it was already damaged with water, chemicals, mechanical or electrical shock

Operations

1. Connect a Pockels cell to the driver, connect the driver to the AC/DC power supply
2. Plug in the AC/DC power supply into the mains grid
3. After the main screen is loaded, select the desired VOLTAGE, REP. RATE, PULSE WIDTH, and the desired OPERATING MODE using corresponding buttons
4. Press START button. Since that moment the driver starts operations. It must be indicated with corresponding pictogram
5. Press STOP button to stop operations
6. Disconnect the AC/DC power supply from the mains grid

Technical notes

- Performance of the module greatly depends on load capacitance. Full performance (see also *Performance* section) is only achievable at 5pF load or about.

Note: higher load capacitance reduces the maximum achievable repetition rate

- **Module's output is bipolar.** It means that 4kV pulse is physically formed by applying +2kV to positive output wire and -2kV to negative (see figure below)

Nevertheless, all descriptions of HV output are given in terms of voltage differences. Please keep it in mind!

- Since Nov 2024 both Synchro inputs have active **leading** edges

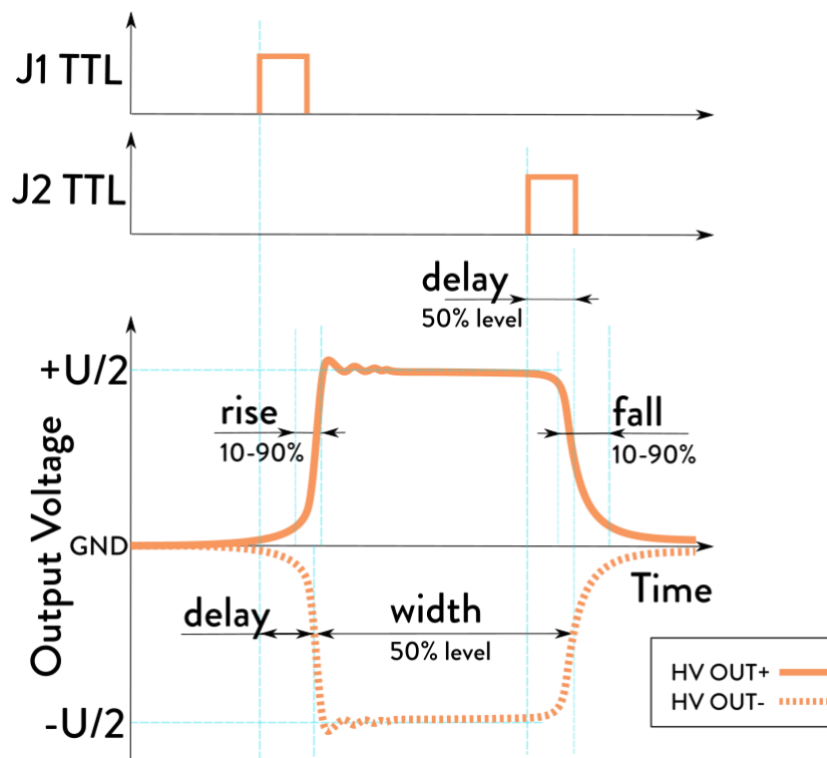

Specifications

Parameter	Value
Input	
Voltage	24VDC
Current	1A max
HV Output	
Description	High voltage pulses applied to the output
Type	Bipolar
Pulse amplitude	0-4kV adjustable
Pulse width	10-1000ns adjustable (*)
Pulse repetition rate	Adjustable: <ul style="list-style-type: none"> - up to 5kHz at 4kV - up to 65kHz at low voltages See also <i>Performance</i> section
Rise / fall times	3-4ns (**)
Load capacitance	5pF recommended 10pF maximum
Synchronizations	
Modes of operation	External synchronization Internal synchronization
Input-to-output delay (in External synchronization mode)	<10ns
Jitter (in External synchronization mode)	<0.2ns
Cooling	Forced air cooling with embedded fan

Protections	From overheating
Environmental	
Operating temperature	0...+40°C
Storage temperature	-20...+40°C
Humidity	10-90%, non-condensing
Mechanical	
Dimensions	182x111x67mm
Weight	<1kg

(*) even shorter on request (see also *How to order?* section)

(* *) even faster on request (see also *How to order?* section)

Dimensions

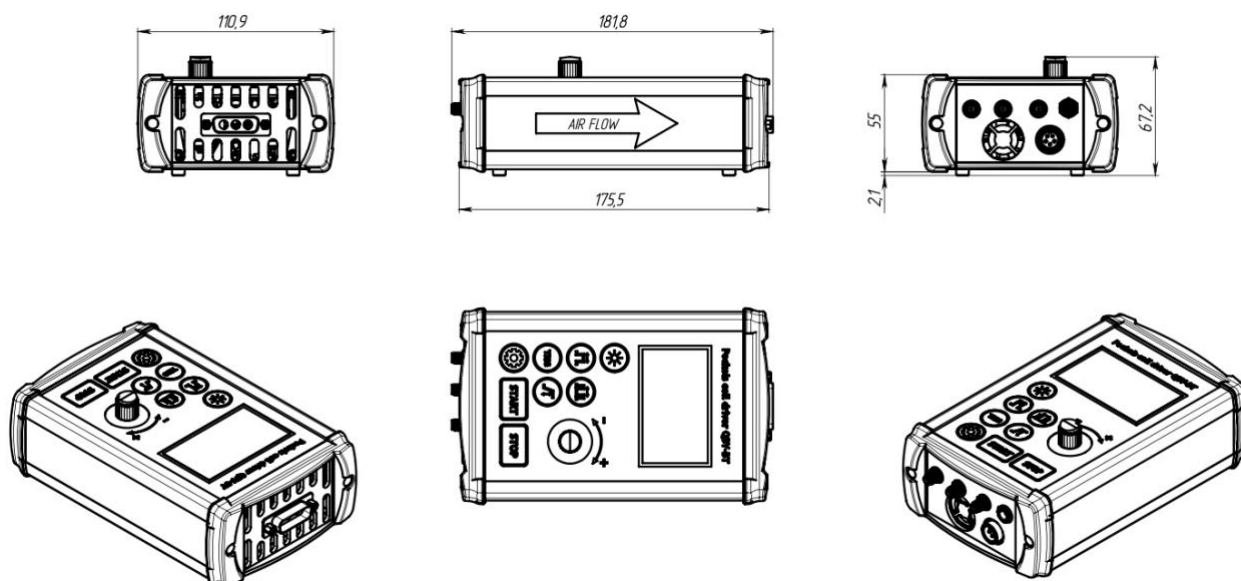

How to order?

By default we supply QBY-BT driver based on QBY-4001 board.



On request we can build QBY-BT driver based on QBU-nano board of any available modification. Advantages are even faster rise and fall times, a shorter pulse width and higher output voltages. The main disadvantage is a pulse repetition rate limited with 0.5-2kHz max. Please contact us for this option.



RS485 interface description

RS485 interface description, Modbus protocol description, demo software utility for Windows OS are available on request.

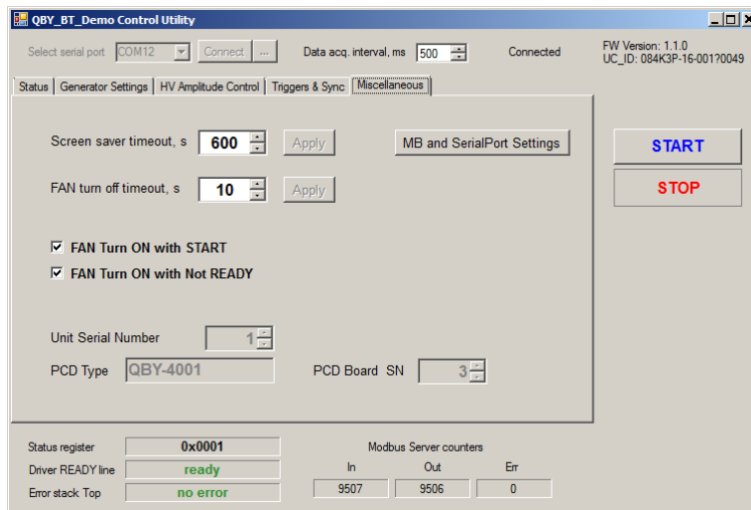
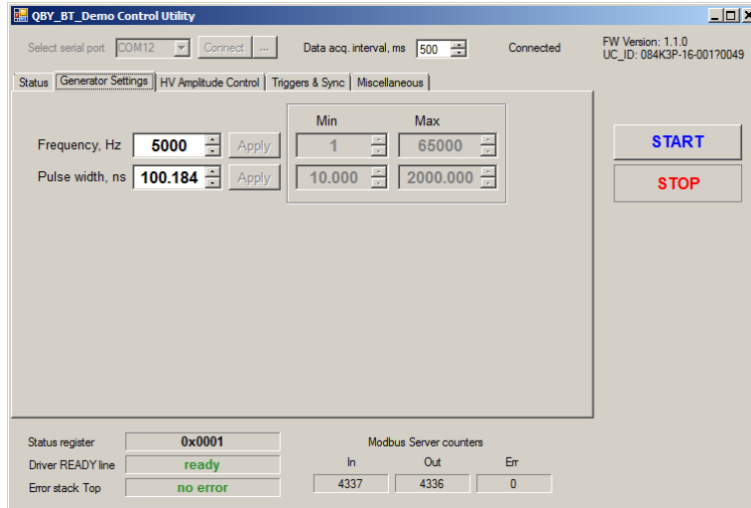

Performance

For continuous operation in internal synchronization modes we guarantee the performance table as follows:

5pF load capacitance, 25°C ambient temperature						
Voltage, kV	0.7	1.0	1.5	2.0	3.0	4.0
Max. rep. rate, kHz	65	60	40	25	10	5

External synchronization mode demonstrates usually a little better performance.

In the burst-mode (= short time operations) performance is increasing approximately twice and may achieve 100kHz value at low operating voltage and load capacitance.

Higher load capacitance decreases the performance.

Output voltage measurements

Important note: please measure the output with symmetrical (differential) high voltage probe only. Measurement made with inappropriate equipment is a common cause of driver's failure.



Typical output

