

PCA-40 capacitor charging module

User manual

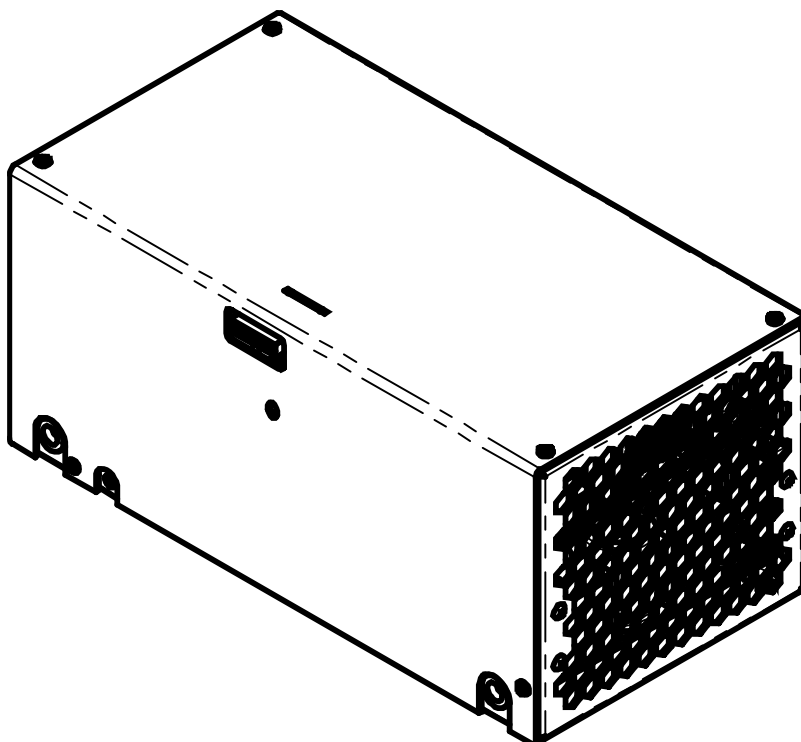

Warning! This equipment may be dangerous.
Please read the entire user manual carefully before using the product.

Important note. Module is sensitive to the reverse polarity applied to the output. If you aren't sure in your application, please contact the manufacturer for the details.

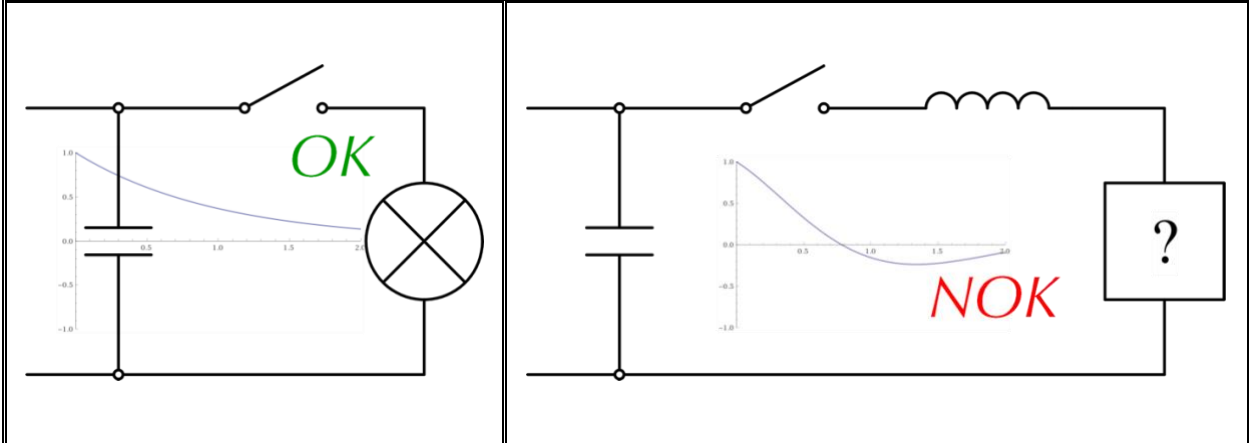











Table of content

WARNINGS.....	3
EXPLANATION OF SYMBOLS	3
OVERVIEW / DESCRIPTION	4
COOLING.....	4
APPEARANCE.....	4
CONNECTORS / PINS / INTERFACE SIGNALS	5
INSTALLATION	8
OPERATIONS	8
FAULTS	8
SPECIFICATIONS	9
DIMENSIONAL DRAWING	11
HOW TO ORDER?.....	12
ENVIRONMENTAL PROTECTION	12
NAME AND ADDRESS OF THE MANUFACTURER	12
EMC COMPLIANCE.....	13
MEANS OF PROTECTION (MOPS)	14

Warnings

	Warning! The equipment is CLASS I ME EQUIPMENT. To avoid the risk of electrical shock, the equipment must be protectively grounded.
	Warning! The equipment should only be used inside the medical equipment, which has means to isolate its circuits electrically from the supply mains on all poles simultaneously.
	Warning! Do not open the enclosure. There are no user-serviceable parts inside the device. Only authorized personnel is allowed to open the device.
	Warning! The equipment is not suitable for use in presence of a flammable anesthetic mixture with air or with oxygen or nitrous oxide.

Explanation of symbols

Symbol	Description
	Refer to instruction manual before handling
IPX0	Particles: No data available to specify a protection rating Water: Non-protected
	Warning, electricity
	Protective earth terminal
	The product should not be disposed of with household waste
	Manufacturing year and month
	Manufacturer's name and address
INPUT	AC power input of the device
HV OUTPUT	Output positive and output negative of the device
INTERFACE	Interface (control) connector of the device

Overview / Description

PCA-40 capacitor charging module is a high-frequency switch-mode converter, which transforms AC input to regulated high voltage DC output to charge capacitors.

Maximum output power is 4000W in modifications for partial discharge and 3500J/s in modifications for complete discharge. The maximum output voltage level (V_{MAX}) could be chosen from 300V to 2000V at the moment of order. Higher output voltages are available upon request.

By default modules are optimized for partial discharge applications. Complete discharge modifications are available on request.

Module is medical grade and complies with the requirements of IEC 60601-1 and IEC 60601-1-2, so it can be used in medical systems without any modifications.

Cooling

Module is cooled with a built-in fan. No external cooling is required.

Appearance



Connectors / Pins / Interface signals

INPUT:

Blue wires (2pcs) – AC input (200-240VAC 50/60Hz)

HV OUTPUT:

Red wire – HV OUTPUT positive

Black wire – HV OUTPUT negative

Cable length warning

Despite the lengths of all cables can be customized on request, we recommend to keep length of HV OUTPUT and INPUT cables as short as possible (max 30-50cm). Usage of longer cables may result in increased electromagnetic emission and/or decreased electromagnetic immunity of the equipment and, correspondingly, in improper operation.

MOUNTING: M4 thread (x4)

Module should be mounted using these threads. Max. screw depth is 10mm.

GROUND: M4 thread

Module should be grounded using this thread. Max. screw depth is 5mm. Grounding should be done before connecting the module to the mains.

Grounding policy

HV OUTPUT negative and INTERFACE return are internally connected to the device ground (chassis). Other grounding policies are available on request.

INTERFACE: MOLEX 0901301120

19	17	15	13	11	9	7	5	3	1
20	18	16	14	12	10	8	6	4	2

PIN (color)	DESIGNATION	DESCRIPTION
1 (-)	TEMP Test point	Module's internal temperature test point. By default the pin is unconnected, but can be activated on request.
2,4,5,6 (black)	Ground	PINS 2,4,5,6 are connected to the circuit ground of all internal circuits. The return signal connection for all interface signals should be made to one of these pins.
3 (yellow)	Voltage Program	A positive DC voltage applied to this pin controls the output voltage set point. 0-10V corresponds to 0-V _{MAX}
7 (blue)	INHIBIT	The high voltage output is inhibited or enabled by this pin 0V – enabled; 5V or free-standing – inhibited
8 (green)	Ready Indicator	This pin is pulled to the ground, when the output voltage is equal to the program voltage (or higher than the program voltage)
9, 10 (red)	+15 V	These pins provide +15V DC that may be used for status LEDs etc. Maximum output current 40mA
11 (orange)	+5 V	This pin provides +5V DC that may be used for status LEDs etc. Maximum output current 40mA
12, 18	N/C	-
13 (white; black mark)	Overtemp (Fault Indicator 2*)	This pin is pulled to ground when some failure occurs. In this case the high voltage output will be also disabled. Failures: <ul style="list-style-type: none"> • overtemperature (approx. 80°C) • mains interruption This Fault indicator is also pulled to the ground on start-up of PCA. In 2-5s, once the start-up sequence is performed completely, the signal is automatically removed.
14 (white; blue mark)	Overvoltage	This pin is pulled to the ground when overvoltage occurs. In case of overvoltage, the high voltage output will be also disabled.
15 (green / brown)	End of Charge Indicator	PIN15 is pulled to ground when the output voltage is below the program voltage. Otherwise PIN15 is pulled to +15V.
16 (blue / white)	Secondary Inhibit	The HV OUTPUT is inhibited (when +15V is applied) or enabled (when 0V is applied or the pin is free-standing). This pin should be used only to control parallel operations of two or more power modules.

17 (violet)	Voltage Monitor	The voltage at this pin is a signal proportional to the instantaneous output. 0-10V corresponds to 0- V_{MAX} Current capability 1,5mA; $R_{out} = 1k\Omega$
19 (white; red mark)	Fault Indicator *	This pin is pulled to ground when some failure occurs. In this case the high voltage output will be also disabled. Failures: <ul style="list-style-type: none"> • output short-circuit • overvoltage • output open-circuit
20 (transparent)	HV ON Indicator	This pin is pulled to the ground, when the module provides power to a load.

* see also **Faults** section

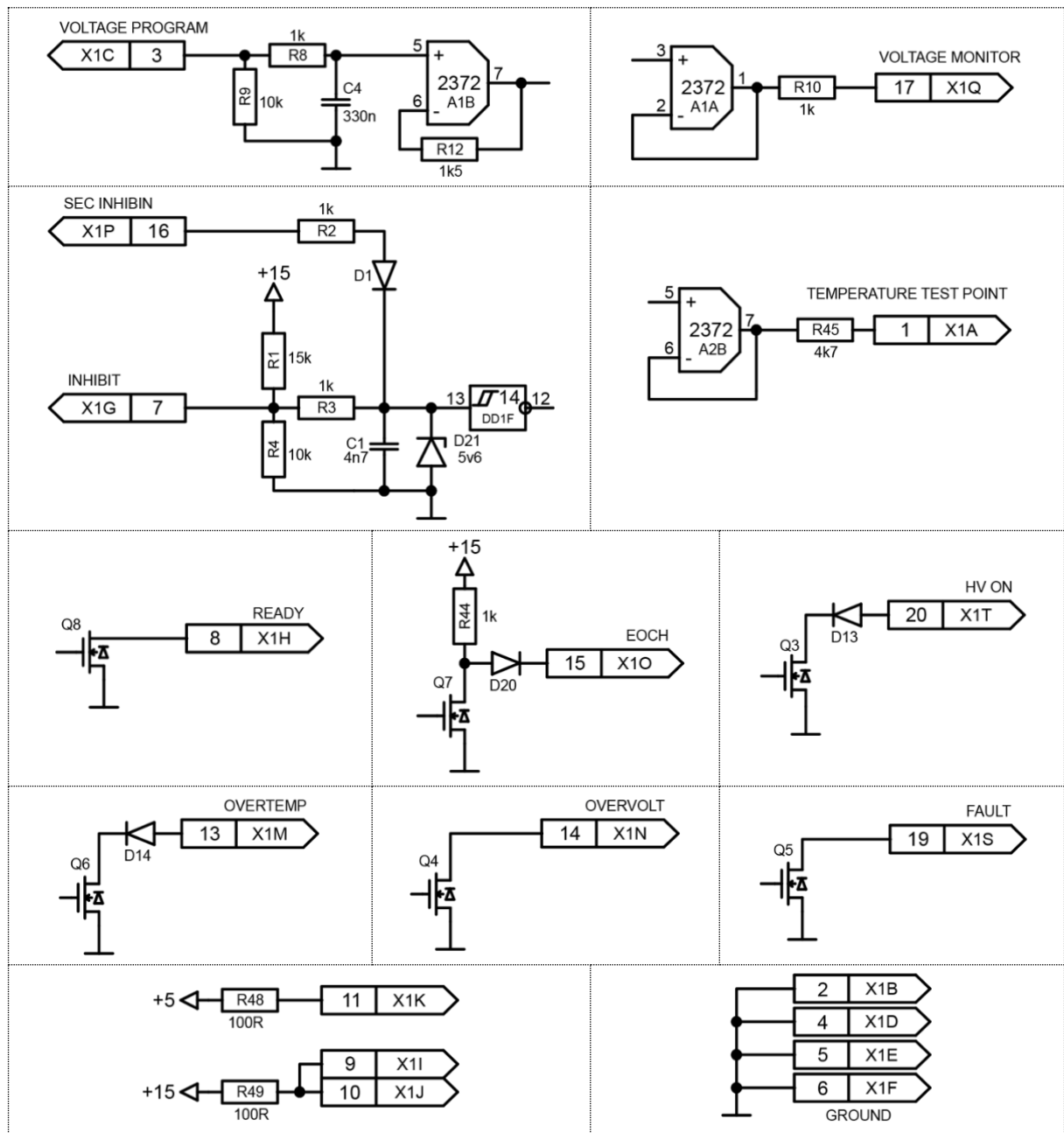

Installation

- Only qualified personnel is allowed to install and perform the connection of PCA-40 into customer's system
- PCA-40 is intended only for capacitor charging applications. The module should only be used inside the medical equipment, which has means to isolate its circuits electrically from the supply mains on all poles simultaneously
- Use four M4 mounting holes on the bottom side of PCA-40 for fixation of the module in your system. Refer to the *Dimensional drawing* section for their location. **Note: max. tightening depth of mounting screws should not exceed 10mm**
- Connect the module to your system protective ground using provided M4 grounding thread. **Note: max. screw depth should not exceed 5mm**
- Connect INPUT, HV OUTPUT and INTERFACE cables according to their functions
- Since module is air cooled, at least 50mm of free space should be provided both at the suction and pressure sides of PCA-40

Operations

1. Disable the high voltage output using *INHIBIT* signal (*PIN7* of *INTERFACE*)
2. Set the desired output voltage in working range ($0V-V_{MAX}$) by applying a DC voltage to the *Voltage Program* (*PIN3* of *INTERFACE*)
3. Apply power to the module, wait 2-5s until module starts
4. Enable the high voltage output (*PIN7* of *INTERFACE*)
5. After operations disable the high voltage output, then disconnect module from the mains

Faults

Fault	Cause of the fault	Troubleshooting
Overvoltage (Pin 19, pin 14)	Voltage on the load exceeds 110% of V_{MAX} level	The fault signal will disappear after elimination of its cause and resetting INHIBIT signal (inhibit and enable the signal referring to the INTERFACE description)
Short-circuit (Pin 19)	HV OUTPUT is enabled, but voltage doesn't increase in predefined time (1.5-2.0s)	The fault signal will disappear after elimination of its cause and resetting INHIBIT signal (inhibit and enable the signal referring to the INTERFACE description)
Open-circuit (Pin 19)	There is no capacitive load connected to HV OUTPUT	The fault signal will disappear after elimination of its cause and resetting (turning off and on) mains supply of the charger
Overtemp (Pin 13)	Temperature of internal elements exceeds the preset limit (approx. 80°C)	The fault signal will disappear automatically after the temperature decreases below the limit (approx. 75°C)
Mains interruption (Pin 13)	Mains has been interrupted (for the time longer than ~1 period)	The fault signal will disappear after resetting INHIBIT signal
Start-up (Pin 13)	PCA has been just connected to the mains	Once initial start-up sequence is performed completely, i.e. in 2-5s, the signal is automatically removed

Specifications

ELECTRICAL

	PCA-40
Input:	
Input voltage	200-240VAC, 50/60Hz
Input current	24-19.5A
Output:	
Maximum output voltage (V_{MAX})	user selectable in the range of 300-2000V (at the moment of order, higher on request)
Nominal output power (partial discharge modifications, can be achieved in regime 70-100% of V_{MAX} , rated input voltage, 25 °C)	4000W
Nominal output power (complete discharge modifications, can be achieved in regime 10-100% of V_{MAX} , rated input voltage, 25 °C)	3500J/s
Output power deratings	Output power is derated when: <ul style="list-style-type: none">- operating voltage is lower than 70% of V_{MAX} (PD modifications)- operating voltage is lower than V_{MAX} (CD modifications)- ambient temperature is higher than 25 °C- input voltage is below minimum rated voltage
Voltage stability	<0.5%

Voltage ripple/hysteresis	<0.5%
Efficiency	More than 85%
Safety:	
Standards	IEC 60601-1 for electrical safety IEC 60601-1-2 for EMC
PFC coefficient	0.98 (Active)
Leakage current	< 300 μ A
Isolations	see <i>Means of protections</i> section
Protections:	from open-circuit from short-circuit from overheating from overvoltage
Cooling:	Forced air (build in fan)
Environment:	
Operation temperature	+10... +40°C
Storage temperature	-20 ... +60°C
Humidity	90%, non-condensing

MECHANICAL

Dimensions	see dimensional drawing below
Weight	approx 4.0 kg

Dimensional drawing

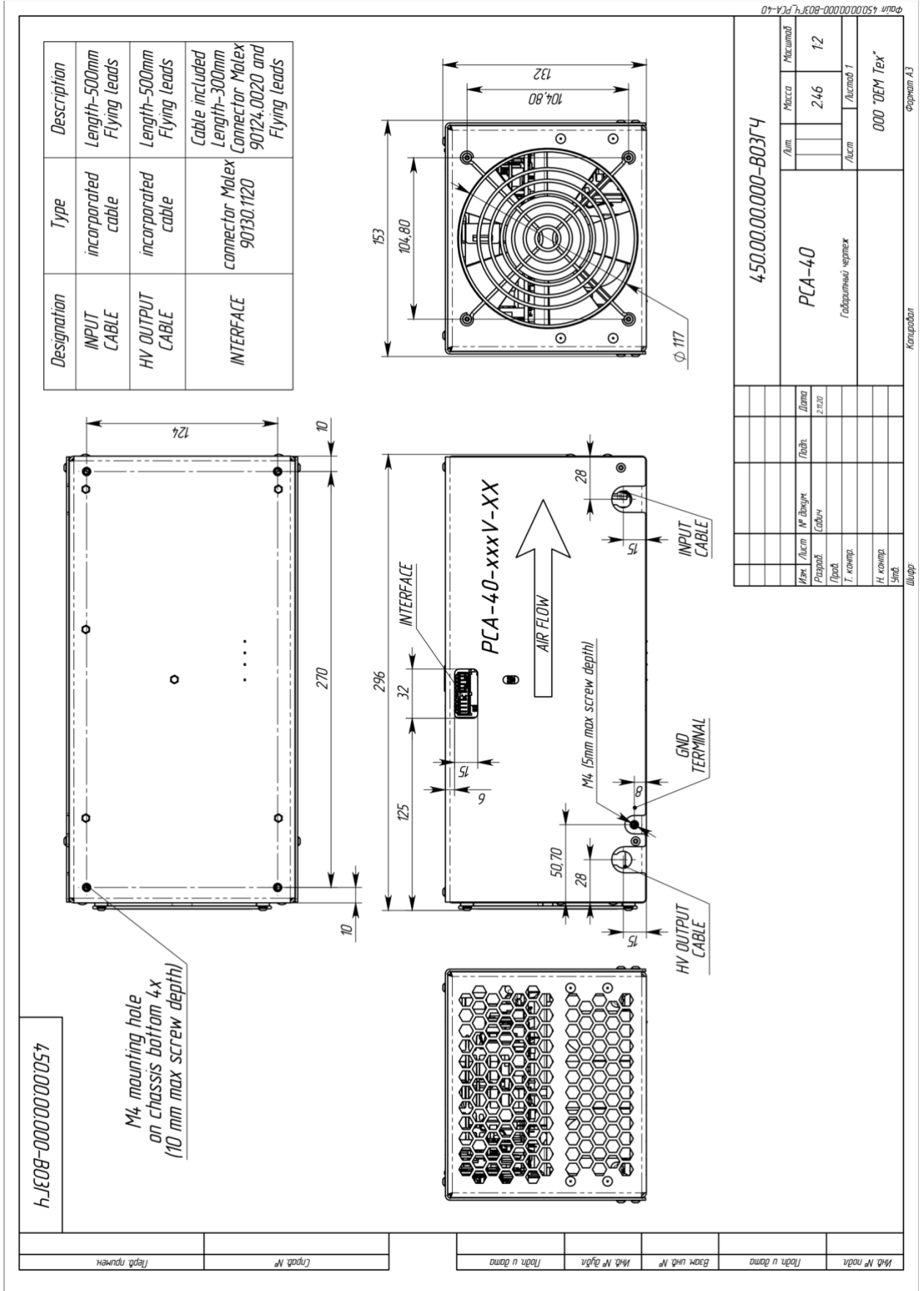

How to order?

PCA-40-XXXX-YY, where:

- XXXX means V_{MAX} voltage (user selectable in the range of 300V-2000V, higher output voltages are available upon request). We would recommend to pick V_{MAX} as close as possible to your operating voltage in order to utilize completely the output power of the device
- YY means either CD (complete discharge modification) or PD (partial discharge modification); if YY is not specified PD modification will be supplied

Examples (the most popular modifications):

P/N	Description	Certificates
PCA-40-500V-PD	200-240VAC input, 4000W/500V output, partial discharge	On demand
PCA-40-700V-PD	200-240VAC input, 4000W/700V output, partial discharge	On demand
PCA-40-800V-PD	200-240VAC input, 4000W/800V output, partial discharge	On demand
PCA-40-1000V-PD	200-240VAC input, 4000W/1000V output, partial discharge	IEC 60601-1:2005 + A1: 2012 IEC 60601-1-2:2014
PCA-40-1500V-PD	200-240VAC input, 4000W/1500V output, partial discharge	On demand
PCA-40-1000V-CD	200-240VAC input, 3500J/s /1000V output, complete discharge	On demand
PCA-40-1300V-CD *	200-240VAC input, 3500J/s /1300V output, complete discharge	IEC 60601-1:2005 + A1: 2012
PCA-40-1500V-CD	200-240VAC input, 3500J/s /1500V output, complete discharge	On demand

* A customized module. There are certain non-compliances with the present user manual. Please contact the manufacturer for the details.

Other modifications are available on request.

Environmental protection

Module should not be disposed of with household waste.

Please, dispose the module in accordance with the regulations for electronic waste management in your country.

Name and address of the manufacturer

OEM Tech O.O.O.
Odoevskogo 129
220018 Minsk, Belarus

EMC compliance

IEC 60601-1-2 Edition 4.0 (2014).

Environment of intended uses: Professional Healthcare Facility Environment

Declared EMC compliance (to be confirmed with test reports for every particular part number):

Test	Standard	Class/ Severity level	Test result
Emission (IEC 60601-1-2 section 7.1-7.2)			
Radiated emission Freq. range: 30 - 1000 MHz	CISPR 11	Group 1 Class A	Complies
Conducted emission Freq. range: 150 kHz - 30 MHz		Group 1 Class A 120 VAC / 230 VAC	Complies
Harmonic current emission	IEC 61000-3-2	230 VAC	Complies
Voltage changes, Voltage fluctuations and Flicker test	IEC 61000-3-3	230 VAC	Complies
Immunity (IEC 60601-1-2 section 8.9 & 8.10)			
Immunity from Electrostatic discharge (ESD)	IEC 61000-4-2	8 kV contact discharges & 15 kV air discharges	Complies
Immunity from radiated electromagnetic fields	IEC 61000-4-3	3.0 V/m 80 MHz ÷ 2.7 GHz, 80% AM, 1kHz	Complies
Immunity from Proximity field from wireless communications equipment	IEC 61000-4-3	List of frequencies (Table 9), from 9 V/m up to 28 V/m, PM (18 Hz or 217 Hz), FM 1 kHz	Complies
Immunity from Electrical Fast transient (EFT)	IEC 61000-4-4	± 2 kV on 230 VAC Tr/Th – 5/50 ns, 100 kHz	Complies
Immunity from Surge	IEC 61000-4-5	±1.0 kV DM/ 2.0kV CM on 230 VAC Tr/Th – 1.2/50 (8/20) µs	Complies
Immunity from conducted disturbances induced by RF fields	IEC 61000-4-6	3.0 & 6.0 V _{RMS} on 230 VAC 0.15 ÷ 80 MHz, 80% AM, 1 kHz	Complies
Immunity from Voltage dips, short interruptions and voltage variations	IEC 61000-4-11	230 & 120 VAC mains; 0 % - 10 ms; 70% - 500 ms; 0% - 20 ms; 0% - 5sec	Complies

Note. The emission characteristics of this equipment make it suitable for use in industrial areas and hospitals (CISPR 11 class A). If it is used in a residential environment (for which CISPR 11 class B is normally required) this equipment might not offer adequate protection to radio-frequency communication services.

Warning. Use of cables other than those specified or provided by the manufacturer of the equipment may result in increased electromagnetic emission and/or decreased electromagnetic immunity of the equipment and, correspondingly, in improper operation.

Means of protection (MOPs)

Declared MEANS OF PROTECTION (to be confirmed with test reports for every particular part number):

Path	MOPs	Path	MOPs
Insulation of Input wires	2x MOPP @ 340Vpk	Input-to-Output	1x MOOP @ Working voltage (depends on modification)
Input-to-chassis	2x MOPP @ 340Vpk	Input-to-Interface	1x MOOP @ Working voltage (depends on modification)
Input-to-input (opposite polarity before fuses)	1x MOOP @ 340Vpk	Output-to-chassis	Output negative is intentionally connected to the chassis
Mains part-to-chassis	1x MOPP @ 420Vpk	Output-to-Interface	Interface is galvanically connected to the output
Mains part-to-secondary circuits	1x MOOP @ Working voltage (depends on modification)	Insulation of Output wires	2x MOPP @ Output voltage (depends on modification)

Besides, module must be protectively grounded, which is considered as 1x MOPP.